

ASSEMBLY INSTRUCTIONS

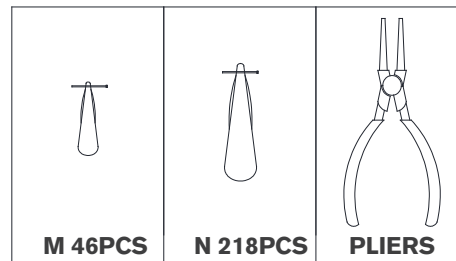
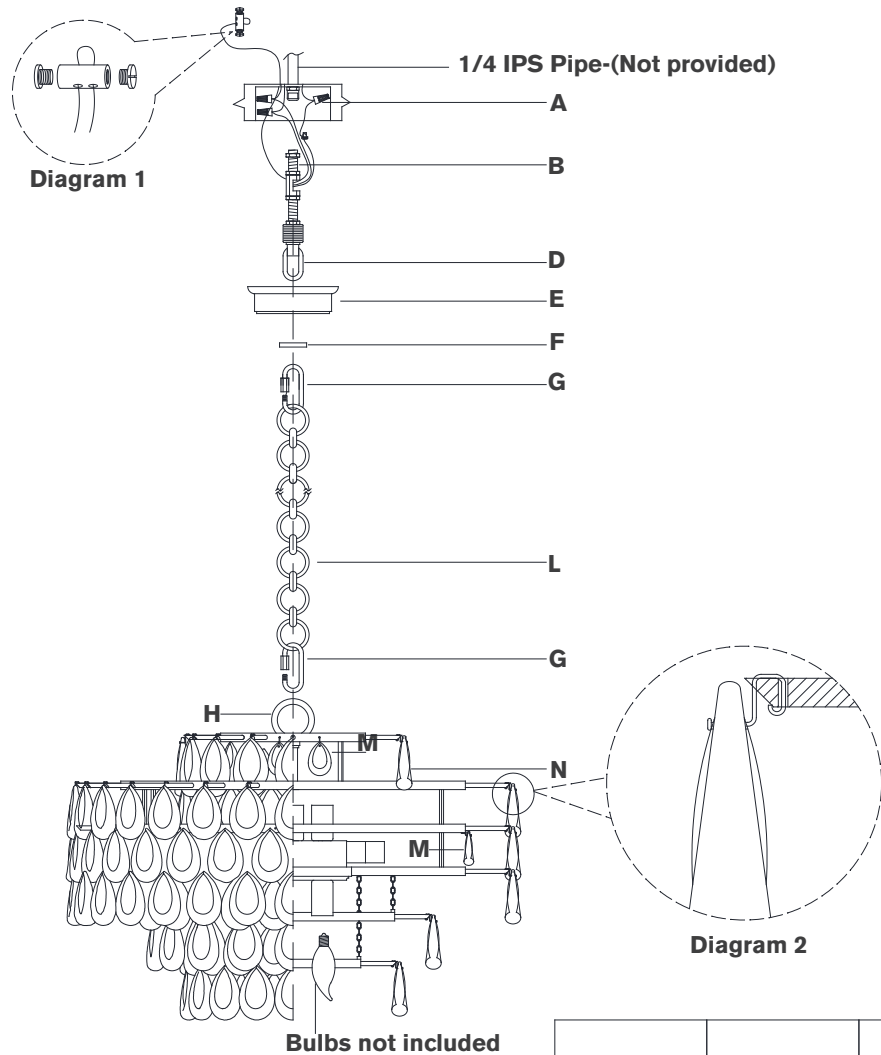

Liscia Chandelier

Item # ARN 5173

NOTICE:

This light fixture should be installed in accordance with all applicable, local installation codes, and by a person familiar with the construction and operation of it, as well as the hazards involved. Inspect item and contents carefully. If any damage or defect is found, do not install. Retain all packaging material until installation is complete and approved.

TOOLS REQUIRED (NOT INCLUDED):

Phillips Screwdriver	Slotted Screwdriver	Chain Pliers
Slip Joint Pliers	Wire Strippers	Measuring Tape
Wire Cutters		

- Carefully remove all parts from the box. Place on a clean, soft surface.
- It is recommended to install a 1/4 IPS threaded pipe, secured to a structural member of the building (not included). Then install threaded nipple (**B**) into receiver and tighten with wrench.
NOTE: Item must be supported independent of the junction box due to hanging weight.
- Remove lock collar (**D**) from chain (**L**) and secure to threaded receiver attached to structural member by tightening locknut.
- Install canopy (**E**) to collar loop (**D**) and secure with collar ring (**F**).
- Determine desired overall length, and amount of chain (**L**) needed. Shorten chain using chain pliers. (Keep extra chain)
- Attach chain (**L**) to collar loop (**D**) and fixture loop (**H**) using quick links (**G**). Secure quick links (**G**).
- Thread fixture wire, ground wire and safety cable through chain (**L**).
NOTE: When you reach the collar loop (**D**), ensure there is no tension on the wires. Cut excess wires, being sure to leave about **12"** to reach the junction box.
- Separate two sides of molded wire, and strip insulation on each 5/8".
- Loosen collar ring (**F**) and let canopy (**E**) slip down chain (**L**) carefully.

ASSEMBLY INSTRUCTIONS

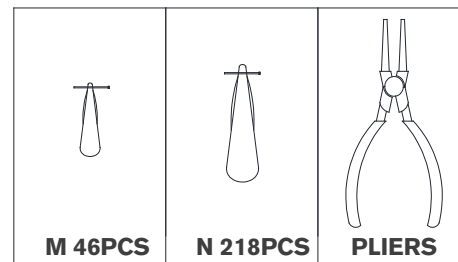
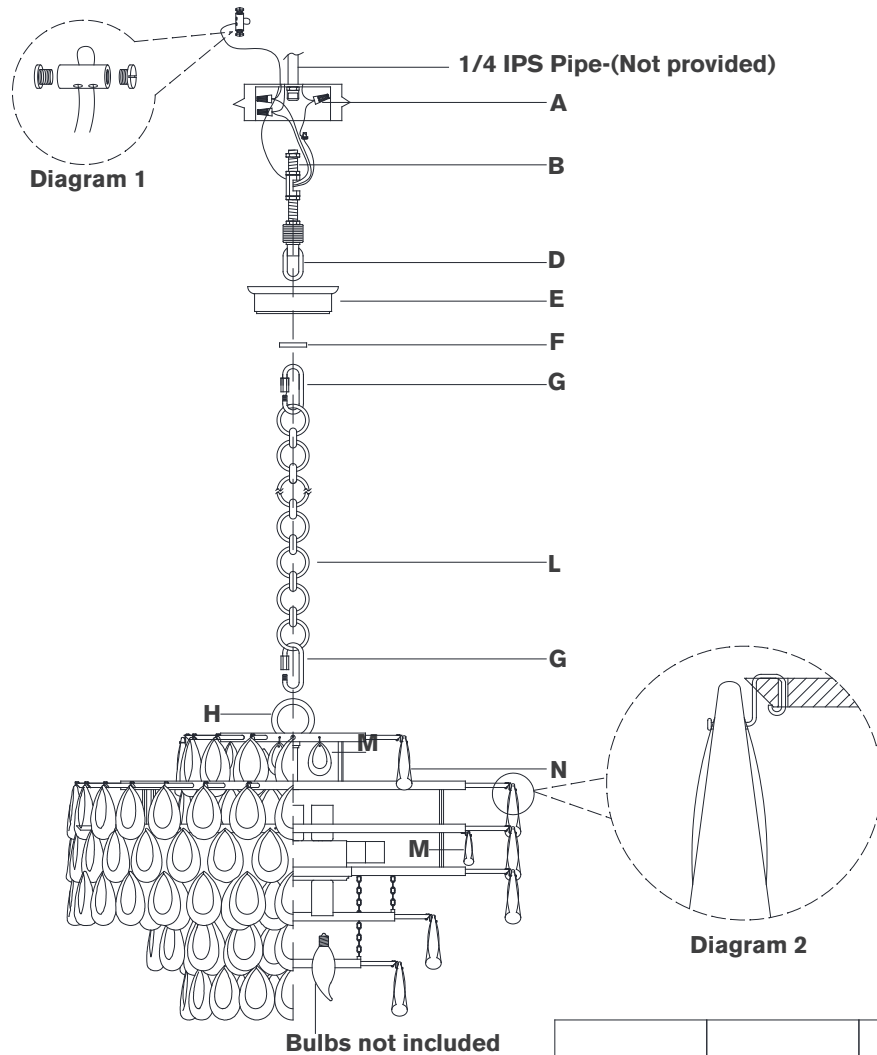

Liscia Chandelier

Item # ARN 5173

NOTICE:

This light fixture should be installed in accordance with all applicable, local installation codes, and by a person familiar with the construction and operation of it, as well as the hazards involved. Inspect item and contents carefully. If any damage or defect is found, do not install. Retain all packaging material until installation is complete and approved.

- Twist all fixture wires together. Slip through center hole of collar loop (D).
- NOTE:** Untwist wires and separate to prepare for connection.
- Loosen cable lock and install to end of safety cable. Run safety cable through junction box and around structural member of building. Insert cable through cable lock and tighten the ends with a screwdriver to secure. (See diagram 1)
- Connect fixture ground wire (bare copper) to the supply ground wire (usually green or bare copper) using wire nut (A).
- NOTE:** It is imperative that the fixture is grounded.
- Connect fixture neutral wire (ribbed) to the supply neutral wire (usually white) using wire nut (A).
- Connect fixture hot wire (smooth with markings) to the supply hot wire (usually black) using wire nut (A).
- CAUTION:** Do not reverse the hot and neutral connections.
- Make sure all wire connections are tight, then carefully tuck into the junction box.
- Install canopy (E) to collar loop (D) and secure with collar ring (F).
- Install light bulbs into the sockets.
- Hang crystals (M) & (N) starting from bottom (layer 6) and working your way the top (layer 1) as shown in figures L6-L1 and diagram 2.

Care Instructions: Clean only with a soft dry cloth or feather duster. Do not use abrasive or chemical agents.

ASSEMBLY INSTRUCTIONS

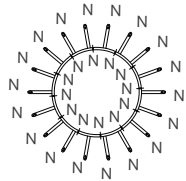
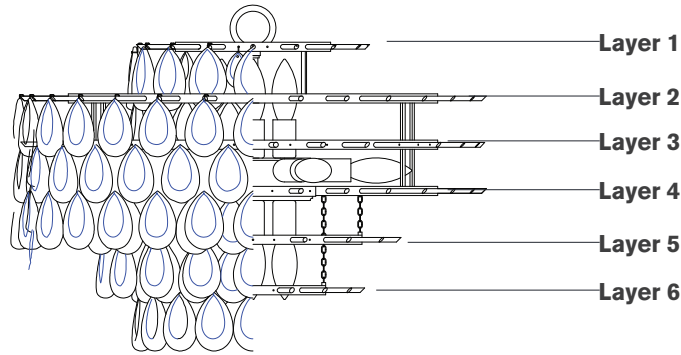

Layer 6

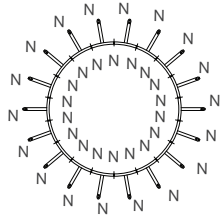

Layer 5

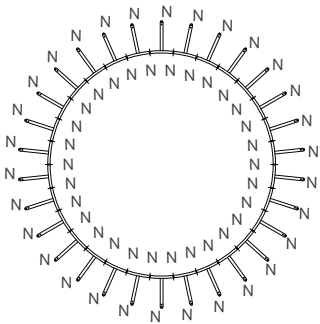

Layer 4

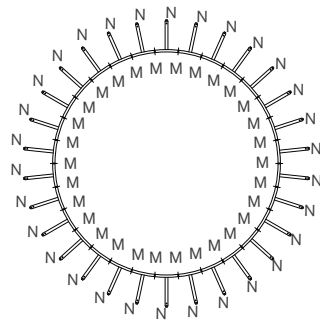

Layer 3

Liscia Chandelier

Item # ARN 5173

NOTICE:

This light fixture should be installed in accordance with all applicable, local installation codes, and by a person familiar with the construction and operation of it, as well as the hazards involved. Inspect item and contents carefully. If any damage or defect is found, do not install. Retain all packaging material until installation is complete and approved.

ASSEMBLY INSTRUCTIONS

Liscia Chandelier

Item # ARN 5173

NOTICE:

This light fixture should be installed in accordance with all applicable, local installation codes, and by a person familiar with the construction and operation of it, as well as the hazards involved. Inspect item and contents carefully. If any damage or defect is found, do not install. Retain all packaging material until installation is complete and approved.

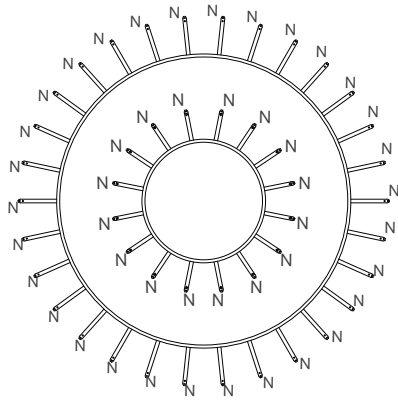

Layer 2

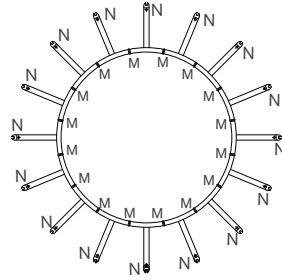

Layer 1